

Installation of a bitumen shingle roofing, Kerabit K+, S+ ja L+

Note before installation

Kerabit bitumen shingles may be installed on roofs with a pitch of 1:5 (11,3°) or greater. Under the bitumen shingles, an underlay membrane must always be installed.

The materials are kept protected from rain and sunshine. Before installation, the rolls of underlay membranes and packages of bitumen shingles must be kept at a temperature above +15 °C for at least for 24 hours. Open the rolls advance in order to allow them to straighten out. This way, folds can be prevented from developing in the finished surface. The time required by the straightening of the membrane depends on the temperature (from one to four hours). When the roofing is being installed, the temperature must be higher than +10 °C and the weather must be dry. Bitumen roofing must not be installed in rain.

If the installation temperature is below +10 °C, the adhesiveness must be ensured, if need be, by warming the adhesive surfaces carefully with a hot air blower (Note: hot work). This is particularly important when doing installation work late in the autumn when heat from the sun is not necessarily enough to warm up the adhesive surfaces so that they stick to each other. Ensure proper adhesion of all the seams/overlaps by walking on them, for example.

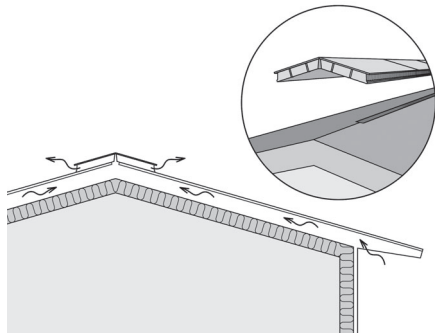

Before starting the installation of the roofing, ensure that the substructure is properly and sufficiently ventilated. Ventilation can be enhanced with Kerabit Ridge Vents, installed along the entire length of the ridge. See Ridge Vent Installation Instructions.

Suitable substrates include rough tongued and grooved boards or moisture proof construction panels. The substrate must be even, dry and must not bend. The tools needed for the installation task are a hammer, tape measure, carpet knife with a hook blade, steel trowel, and application gun. By using a coloured alignment line or a floating rule of the length of the pane, the straightness of the shingle rows may be checked. To cut flashing, plate shears are

needed. Kerabit Sealing Adhesive is to be used for gluing.

For nailing, hot-galvanized, broad-headed clout nails are used. Note that the nails must penetrate the wooden substrate. If a pneumatic nailer is used, the percussion force needs to be so set that the nail head is straight and at the correct height, and does not penetrate the roofing. Instead of nails, big flat-headed screws can also be used in case the tips of the nails must not be visible under the wooden underlay.

Before installation of an underlay membrane, attach triangular battens at the base of chimneys and upturns, and if need be, also on the verge. Bitumen roofing felts are always installed from the lower eaves upwards to avoid backwater laps. Note that you should install the roofing above chimneys and major penetrations only after the penetrations are completed (see, Chimney and large lead-throughs). A roofing installed in accordance with the installation instructions has no nails visible. Mix together at least five packets of shingles so that the roof colouring is more even. Any variation in hue of the shingles will be smoothed out over the course of one year due to UV radiation.

Renovation sites

If the old bitumen roofing is not removed, it is to be checked that the roof ventilation is working, the substructures are in order, and the substrate is flat. In such a case, a new underlay membrane and bitumen shingles can, if need be, be installed over the old roofing.

Any folds/bulges must be split and attached to the surface using adhesive and nailing before the new roofing is laid. The nails must penetrate the wooden substrate.

Installation of an underlay membrane

The installation of a roofing starts with installing an underlay membrane. Underlay membranes with an adhesive edge may be installed both vertically or horizontally. The installation direction affects the fluency of installing and possibly also the need for the membrane material (the dimensions of the roof in relation to the length of the roll). In case of a steep roof, vertical installation is recommended, because it is difficult to have the membranes straight in a horizontal installation, if the roof inclination exceeds 1:4. If you install the underlay membrane horizontally, check for further information in the instructions Installing Kerabit underlay membranes on high-pitched roofs.

Valleys i.e. mitre-cuts

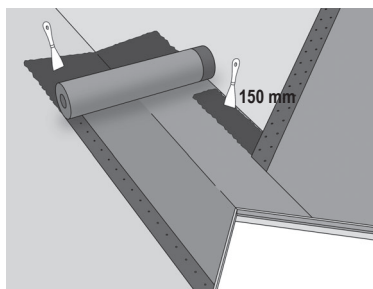

Start installing the underlay membrane at the valley. Install the underlay membrane to the bottom of a valley and glue it throughout to the underlay with a sealing adhesive (a glue layer of approximately 1 mm), and nail by the edges at intervals of 100 mm. At a later stage, the underlay membranes from the panes are installed 150 mm on top of a membrane at the bottom of the mitre-cut. Cut the ends of the membranes to the line of the valley with the help of a floating rule, and fix carefully on the entire length the overlap with sealing adhesive. Do not nail on the seam!

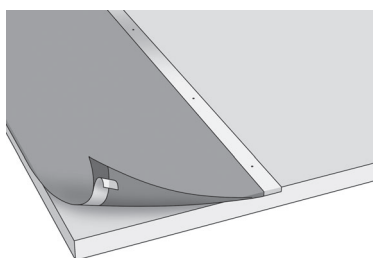

Next, lay out the underlay membrane in the direction of the verge in a straight line and slightly over the edges so that the edges can be folded approximately 15 mm under the lower edges of the boarding. Nail the top edge at interval of 100 mm. Pre-nail the membrane at approximately every 1 m through the protective plastic cover on the upper surface. Remove the protective plastic cover of the adhesive edge of the lower surface and press the membrane tightly to the underlay. If need be, nail at the end to the outer edge of the underlay boarding. Lay out the next membrane, nail at intervals of 100 mm (start at approximately 200 mm from the edge having the adhesive strip on the lower surface) and pre-nail it at intervals of approximately 1 m through the plastic protective cover of the adhesive edge on the upper surface. Turn aside the membrane edge on the side of the verge from the top of the first membrane. Remove the protective plastic cover from the upper surface adhesive edge of the first membrane and nail the membrane onto the underlay in a zigzag pattern with 100 mm spacing. Note! The distance of nails from the edges of the adhesive strip at least 15 mm. Remove the protective plastic cover from the underside adhesive edge of the second membrane and press the adhesive edges against each other (so that the zigzag nailing of the first membrane is covered). Finish the fixing of the top edge by nailing at the seam. Repeat the same steps until the pane is finished.

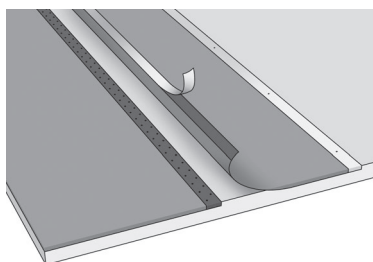

Ridge

If there will be no dedicated ventilation of the ridge, the underlay membrane is installed as follows:

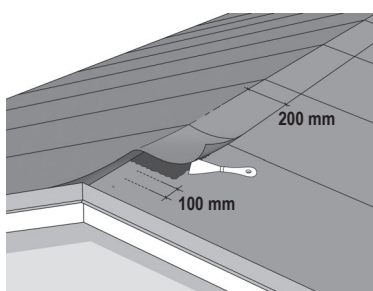

Option A) Bring the membranes of the first pane flush with the ridge, and nail at the top edge to the underlay every 100 mm. Turn the membranes of the second pane 200 mm over the ridge and glue throughout with sealing adhesive to the membrane on the second pane. Do not nail on the seam!

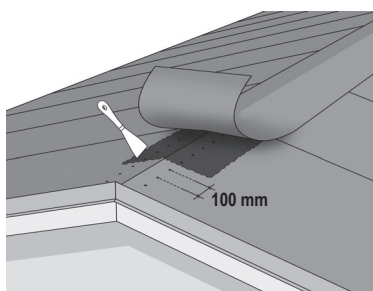

Option B) Bring the membranes of both panes flush with the ridge, and nail at the top edge to the underlay every 100 mm. Split the membrane in the longitudinal direction into two strips. Glue a strip onto the ridge. A ridge strip must not be nailed at any other points than at possible extensions. Overlap end extensions by 150 mm, nail the end of a previous membrane at every 100 mm to the underlay and glue the topmost membrane by the width of the overlap to the lower one.

Extensions

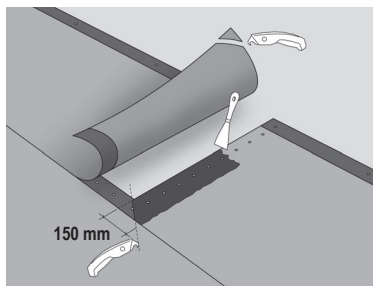

Overlap the membranes by 150 mm. Cut off pieces from the corners of the membrane as illustrated in the attached drawing. Nail the end of the lower membrane to the membrane every 100 mm. Glue the topmost membrane by the width of the overlap to the lower one.

Upturns, chimneys and other large lead-throughs

Install the underlay membrane to the top edge of the triangle batten and nail to the batten at intervals of approximately 100 mm.

Note! On chimneys of a log house, make a plywood collar at least 400 mm high around the chimney. Do not attach the collar to the chimney (be sure to leave a gap between the chimney and the collar to allow for settling). Fix the collar to the roof structure with a triangle batten. Continue as in the above.

Eaves

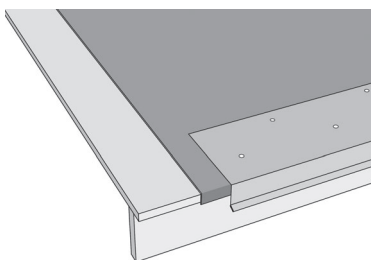
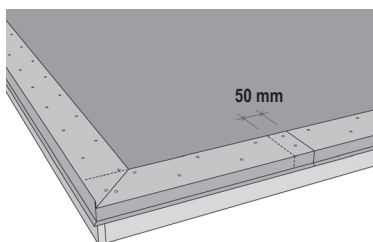

After the underlay membrane has been installed, Kerabit eave flashing is installed on the lower eaves. Before installation, the protective plastic cover is removed from the flashing. A gap of approximately 10 mm must be left between the face of the flashing and the facing board. The flashing is fixed by clout nails or KFR-headed thin sheet screws at intervals of 100 mm in a zigzag pattern. The lowest row of fixings must be at a distance of approximately 50 to 70 mm from the fold of the flashing. Extensions of flashings are over-

lapped by at least 50 mm. The drip of the topmost flashing is opened, and the drip of the lower flashing is installed inside the opened one. The extension is finally fixed by two nails/screws.

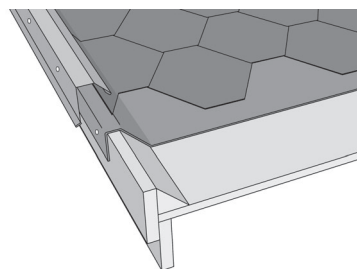
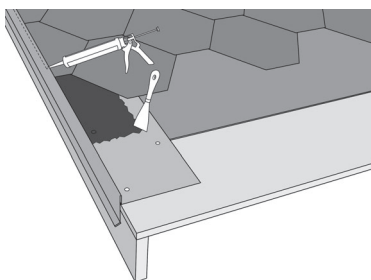
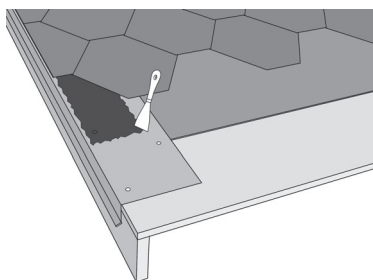

Kerabit Eaves flashing.

Kerabit Eaves flashing with ridge

Kerabit Verge flashing for triangular batten strip

For verges, there are three options: Kerabit Eaves flashing, Verge flashing with ridge, and Verge flashing. The first two referred to must be installed before installing the bitumen shingle roofing, similarly to the flashings of the lower eaves. The installation of the verge flashings is started at the lower eaves towards the ridge. This avoids superimposed seams.

Note! When using Kerabit verge flashing with ridge, sealing adhesive is finally added to the seam of the membrane and flashing.

When using Kerabit verge flashing, triangle batten strips of 50 x 50 mm are first attached, and facing boards to their sides. The underlay membrane is folded over the facing board and fixed to the facing board. At a later stage, the bitumen shingles are turned up to the top edge of the triangle batten. As the last step, the verge flashings are fixed to the facing board. They are fixed at intervals of approximately 100 mm.

For sheet metal plating of top eaves, Kerabit Verge flashing with ridge or Verge flashing is used.

For more information, check the installation instructions of the Kerabit eaves flashing.

Installation of a bitumen shingle roofing

Valley

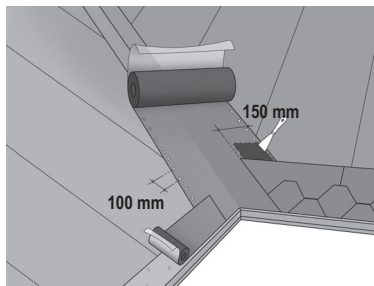

Attach a bitumen shingle-coloured self-adhesive Kerabit Valley membrane to the valley by nailing it down at 100 mm intervals at the top edges.

At a later stage, after installation of the eaves strip, the shingles are overlapped over the valley membrane by at least 150 mm. An area without shingles, at least 150 mm wide, is left at the bottom of the valley. The ends of the shingles are cut to the line of the valley with the help of a floating rule, and carefully fixed with sealing adhesive in a 150 mm wide section, gluing layer by layer. Nailing over the valley underlay using nails is not recommended.

Eaves strip

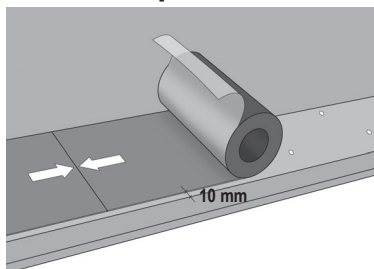

Next, attach the self-adhesive Kerabit Eaves Strip over the lower eaves flashing. Place the lower edge of the strip approximately 10 mm upward from the fold of the flashing. Remove the plastic film covering from the lower surface of the eaves strip and press the strip down. The extensions of the strips are installed firmly against each other.

Installation of bitumen shingles

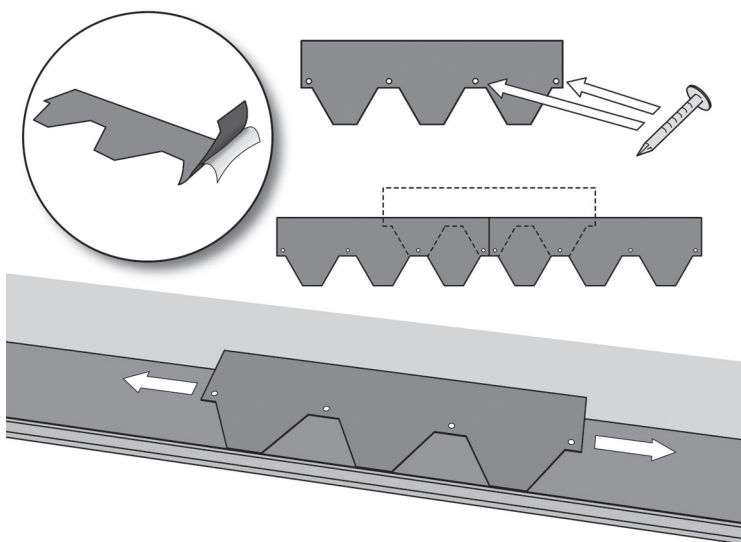

Start the fixing of bitumen shingles at the centre of the lower eaves. Remove the plastic film protecting the adhesive surface of the bottom edge of the shingle (Note, the plastic films at the top edge is left in place), align the tips of the shingle with the bottom edge and press the shingle in place. Make sure the tabs of the bitumen shingles adhere properly. Where necessary, gently warm the adhesive surface using a hot air blower.

Each Kerabit K+ and S+ bitumen shingle is fixed with four and Kerabit L+ with five clout nails approximately 20 mm from the top edge of the slots, not from the top edge of the shingles. Make sure that the nails penetrate the underlay membrane.

Kerabit K+ ja S+: After nailing down the first row of bitumen shingles, position the tabs of the next row with the slots of the first row. This way, the new row of shingles covers the nails of the previous row.

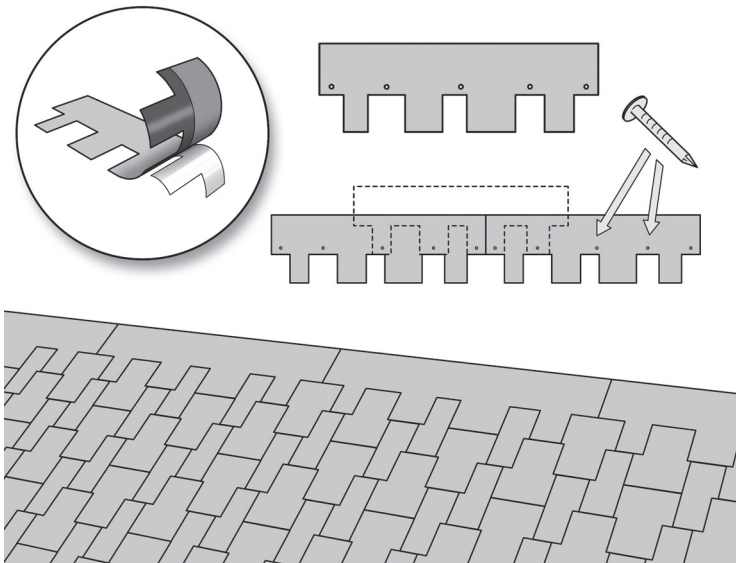

Kerabit L+: After you have nailed the first row of bitumen shingles, position the shingles of the subsequent rows so that the centre of the widest tab falls at the extension seam of the shingles. The middle slot fastener must be nailed close to the right side of the slot.

Ensure that the rows of shingles are installed straight by using a floating rule or line that extends for the length of the pane. Remember to keep an eye on the symmetry of the pattern as the installation progresses (does not apply to L+).

At the verge, glue the ends of the shingles to the eaves flashing over the distance of at least 100 mm.

Lead-throughs

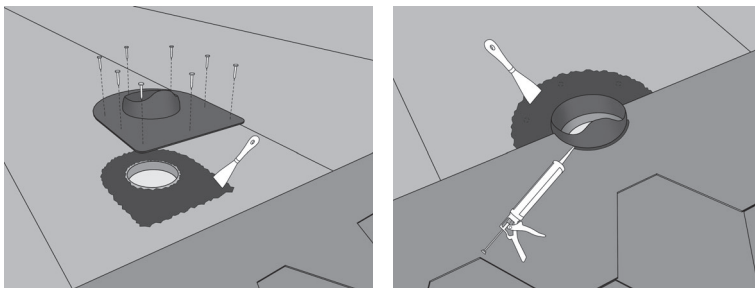

The lead-throughs are sealed with suitable leadthrough seals as follows: Glue the flange of the lead-through seal throughout to the underlay membrane over the distance of at least 150 mm. Screw/nail the edges of the flange. Cut an opening of the shape and size of the lead-through to the bitumen shingles to be placed over the leadthrough. Glue the bitumen shingles to the flange and the shingle below with sealing adhesive over the distance of at least 150 mm. Finish the base of lead-through by applying sealing adhesive.

Chimney

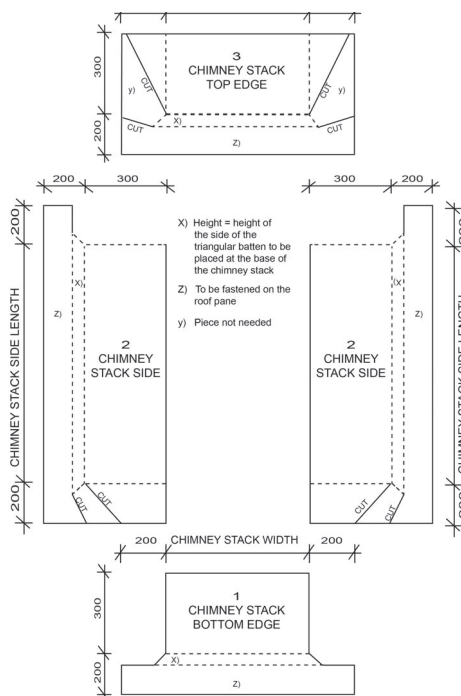
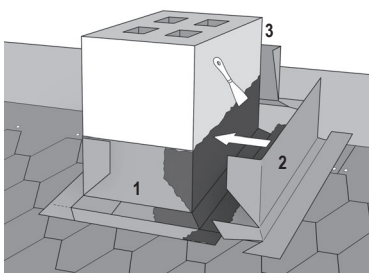

Upturn pieces of a chimney are installed when installing bitumen shingles has progressed to the top edge of the chimney. Cut upturn pieces according to the attached image from Kerabit Valley membrane or Kerabit Titan. Glue the pieces throughout to the chimney and the underlay in the numerical order of the image. Below and on the sides of the chimney, the pieces overlap the bitumen shingle roofing, on top of the chimney below the roofing. Glue the shingles on top of the chimney carefully to the upturn piece with sealing adhesive. Mechanically anchor the upturn pieces by their top edges approximately every 100 mm.

Upturns

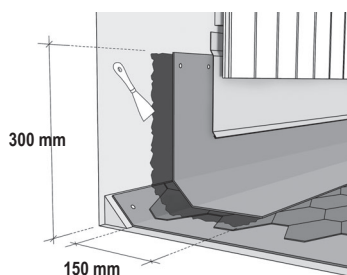

Cut the membrane strips needed for the upturns from Kerabit Valley Membrane or Kerabit Titan. The upturn strips need to extend at least 300 mm on the vertical surface and at least 150 mm over the shingle roofing. Glue the strips throughout and mechanically anchor them at the top edges. At extensions, overlap the membranes by 150 mm and nail the end of the lower membrane at approximately every 100 mm to the underlay.

Ridge / hip

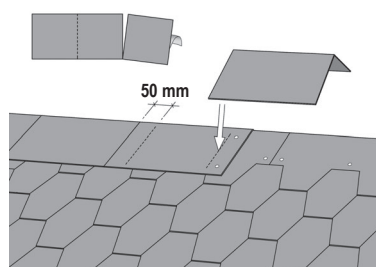

The ridge is made of Kerabit Ridge shingles. The nails of the topmost row of shingles must go below the ridge shingles. Detach the ridge shingles (3 pcs) from each other by bending. Remove the plastic cover, bend and press the ridge shingle in place. Fix with four nails at the end so that the nails go under the subsequent ridge shingle (overlap the ridge shingles by approximately 50 mm). The final ridge shingle is attached using only sealing adhesive and not nails.

The hip is implemented in the similar manner, starting with the lower eave.

Special instructions

Going around a porch or similar structure

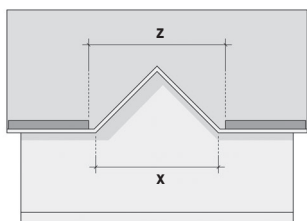

If the lower eave does not continue continuously due to a porch or a similar structure, the process following the installation of the eaves strip is as follows: the seams of the shingles on different sides of the structure must be so aligned that the pattern of the shingles can be made to align correctly above the porch. The gap (z) between the seams must be divisible by $1/3$ m in the K+ and S+ models, and by 1 m in the L+ model, as measured across the spot in question. The measurement must be carried out as per the attached drawing by measurement lines drawn across the porch at right angles.

In the drawing $z = (x+1)$ rounded up to the subsequent integer in metres. For example, if $x = 4,5$ m, $z = 6$.

Protrusion on the lower eave

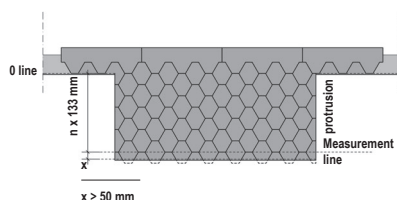

If there is a protrusions on the pane, the start must be measured so that the shingles can be made to come into contact in the same line at the eaves of the actual pane. From the dimension of the eaves line, the required number of shingle runs is counted outwards. The run of one row of shingles is 133 mm. If the dimension of the protrusion is divisible by 133 mm, the division is even.

If the dimension x exceeds 50 mm, the bottoms of the slots of the first row of shingles are aligned on the measurement line and the portion of the shingles exceeding the ridge line is cut off. Glue the tabs of the shingle by sealing adhesive to the eaves strip.

If the dimension x is 50 mm or less, the first row of shingles may be started upwards from the measurement line over the eaves strip.

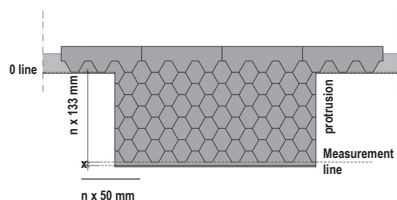

Finishing the roof after installing shingles

Protect the chimneys and other upturns after the installation of the shingle roofing with sheet metal cladding, for example, so that water cannot get between the membrane and the vertical surface. If any fixings must be installed on the roof afterwards, ensure their waterproofing.

Roof maintenance instructions

Check the condition of the roof at least twice every year and clean it, if necessary. To remove moss and lichen, Kerabit Bio Plus moss remover, for example, may be used. Fix possible damages immediately. If you remove snow from the roof, reduce it layer by layer, and leave a snow layer of approximately 10 cm thick.

25.8.2023